

NORFAB 4' Coyote Extension Kit Materials Checklist

Norfab has taken great care to ensure all parts are of quality material and complete. Please check the unit over carefully. Should you experience any problems or have any questions, **DO NOT CALL THE STORE**, contact NorFab immediately at 1-800-465-2918.

Note: Actual floor size is 8' wide (front) x 11' 8-1/4" deep (sides).

2 – 48" x 48" side wall extension panels, EZ-Panel

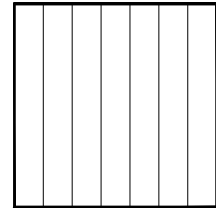

4 – 36" x 48" sheets 7/16" OSB Roofing material

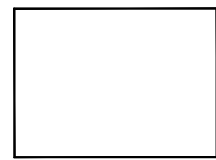

2 - 2x3 x 48" Top plates

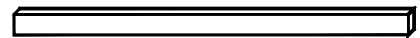

4 - 2x3 x 45" Wall studs

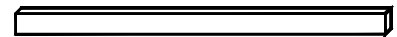

8 - 2x3 x 36 1/2" Rafter boards

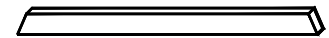

4 - Large gussets

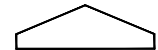

8 - Small gussets



1 - Bag 3" coated nails



1 - Bag 1 1/2" coated nails



Sketches are not to scale.

See your dealer for your choice of flooring and roofing. **Be sure of actual floor size.**

Actual floor size is 8' wide (front) x 11' 8-1/4" deep (sides).

In order to incorporate this extension kit with the 8' x 8' Coyote Shed, replace the following seven steps with their corresponding steps found in the instruction manual provided with the 8' x 8' Coyote shed.

Norfab has taken great care to ensure all parts are of quality material and complete. Please check the unit over carefully. Should you experience any problems or have any questions, **DO NOT CALL THE STORE**, contact NorFab immediately at 1-800-465-2918.

Note: Actual floor size is 8' wide (front) x 11' 8-1/4" deep (sides).

STEP 3b:

Lay out both two-piece top plates. Measure 46 1/8" in from the end of the 92 1/4" top plate to mark the center stud. Then measure 24" out from this point to mark the other two stud locations. On the 48" extension plate, mark 2" from its end to find the center point of the second extension wall stud and 24" from this point to mark the last stud location. The first extension wall stud must be centered on the joint between the two top wall plates to connect the top plates together. The end studs should be flush with the outside edge of the top plate.

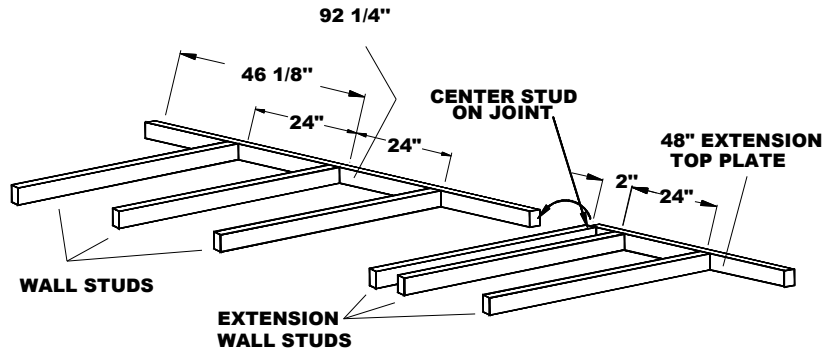

Nail the eight wall studs to the top wall plates, centered on your marks.

STEP 5b:

The splice in the top plate should be at the rear.

NOTE: BASE PLATES OR FLOORS SOLD SEPARATELY AND MUST BE USED TO STABILIZE THE WALLS TO CONCRETE.

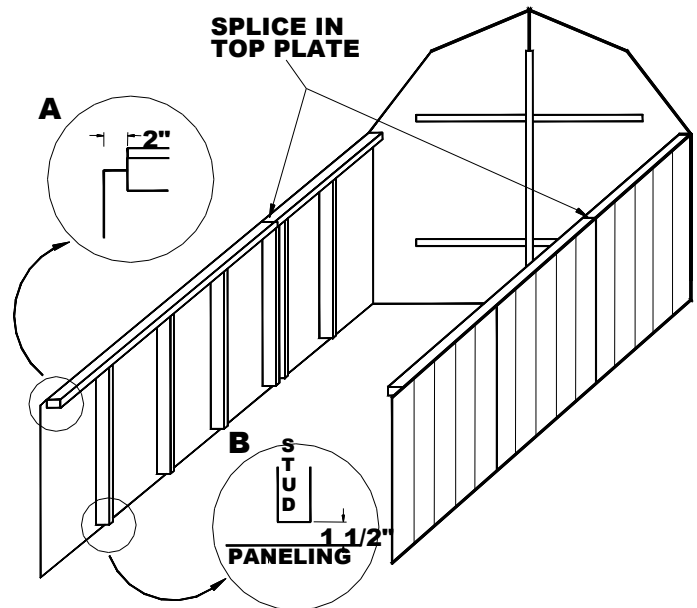

Customer Service Hotline 1-800-465-2918
NORFAB 4' Coyote Extension Kit

STEP 10b:

Assemble additional rafters as in Step 10.

Note: Rafters **must** be 96" (8') wide from tail to tail.

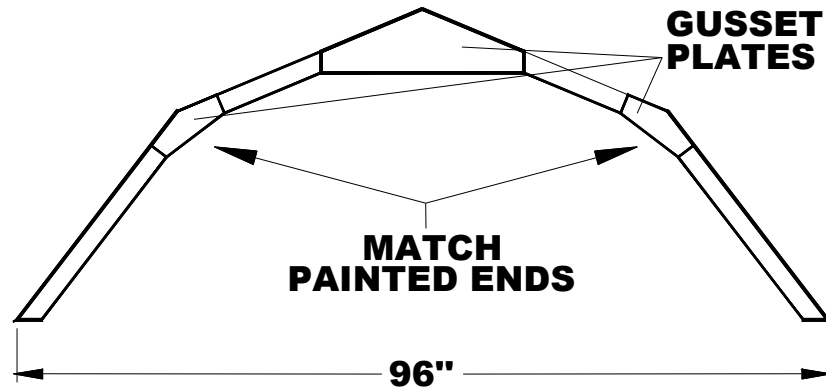

STEP 11b:

Stand the assembled rafters, centering them on top of the wall studs and nail them in place with 3" nails. Do not install a rafter over the wall stud that is at the splice in the top plate.

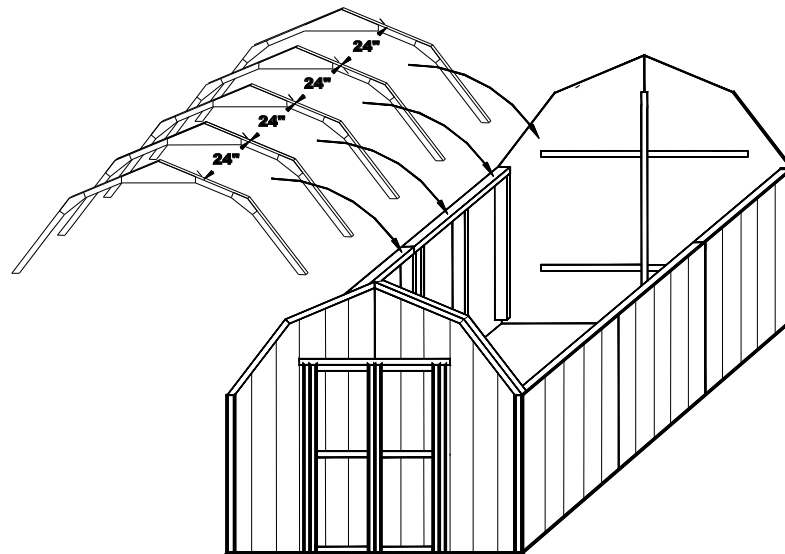

Customer Service Hotline 1-800-465-2918
NORFAB 4' Coyote Extension Kit

STEP 12b:

Install the lower 36" x 96" roof sheathing so that they are flush with the front and rear fascia boards and side walls with 1 1/2" nails. Next, install the 36" x 96" roof sheathing at the peak. Finally, nail the four smaller pieces of roof sheathing to the rear of the shed.

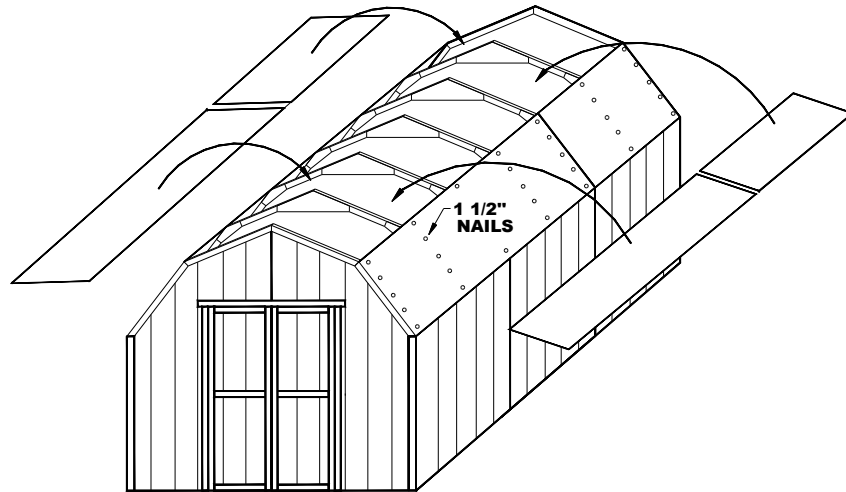

Enjoy your new NORFAB shed!

Customer Service Hotline 1-800-465-2918
NORFAB 4' Coyote Extension Kit