

14 Ft MONARCH GAZEBO

INSTRUCTIONS FOR ASSEMBLY

Norfab has taken great care to ensure all parts are of quality material and complete. Please check the unit over carefully. Should you experience any problems **DO NOT CALL** the STORE! Contact Norfab immediately at 1 800 465 2918 and they will look after you.

Updated January 6 2001

Tools required for construction: hammer, Philips and No. 2 - Robertson screwdrivers or drill bits, utility knife, step ladder, tape measure, saw, stapler, and sand paper.

PLEASE READ INSTRUCTIONS CAREFULLY

Step 1:

Make sure that the construction site is large enough to accommodate the gazebo. The structure when completed is 10 ft. high and is 14' 7" in diameter. The building site should be level to ensure proper fit of gazebo components.

Step 2:

Unpack the gazebo. Please handle the lattice panels carefully. Use the materials list, found at the end of these instructions, to identify each part and group all floor sections, wall panels, and roof components in their respective groups. If you have any questions please contact Norfab.

Step 3:

Lay out the floor sections in the desired location. The floor sections should be placed as shown here. Be certain that one of the sides of the decagon is facing the desired direction of the door.

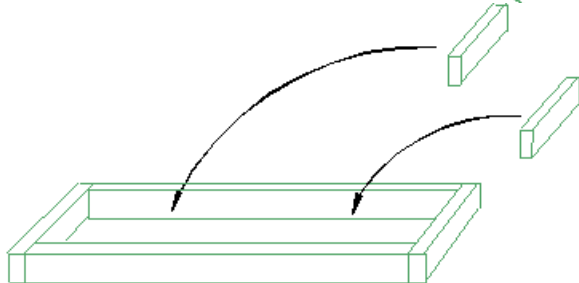
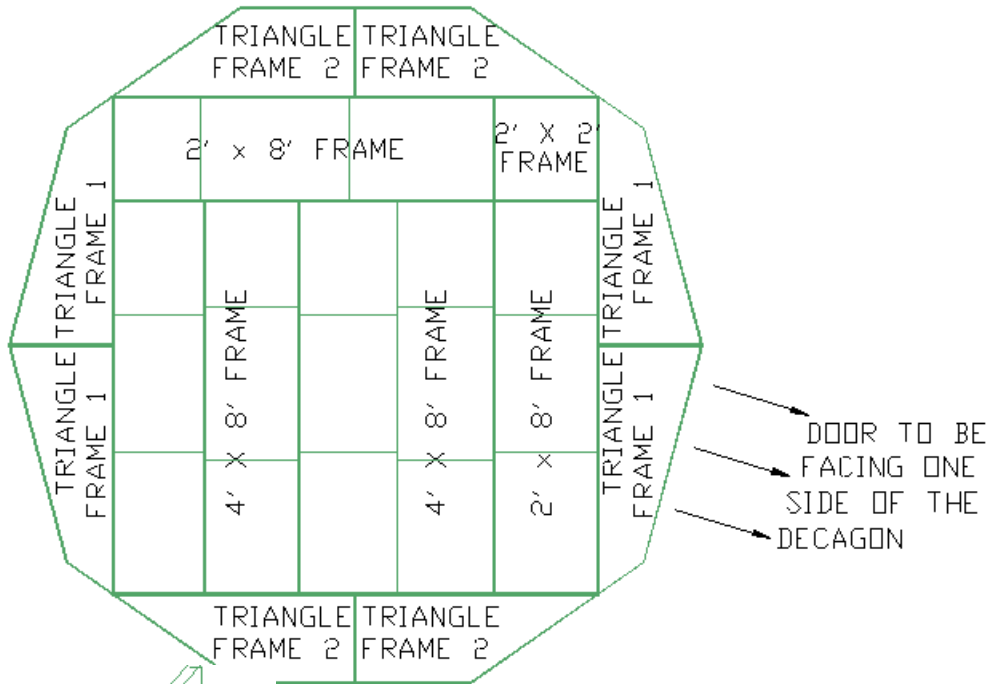

For packing purposes, one of the two 4'x8' frames does not have its 2" x 4" x 21 3/4" cross blocking installed. Nail the four provided 2" x 4" blockings into place with 3" nails as previously installed with the other 4'x8' frame.

14' MONARCH Gazebo

- Page 1 -

The floor system must be blocked up to ensure a level base. The figure to the right shows the suggested blocking. The blocking materials (not supplied) are three 16' and two 14' - 4" x 4" pressure treated timbers. Cut one of the 16' timbers to 14' 6" and the remaining two of them to 10 ft. and 4'6" lengths, cut the 14' - 4" x 4" timber to 12' 10". (Concrete or wood blocks are also suitable for blocking. A minimum of 29 blocks should be used to properly support the floor system, one under the each floor panel intersection, and one under each corner.)

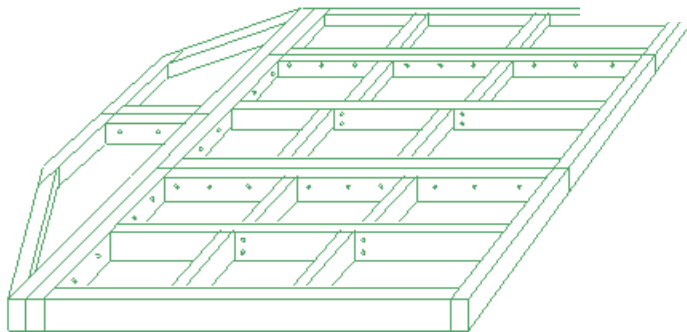
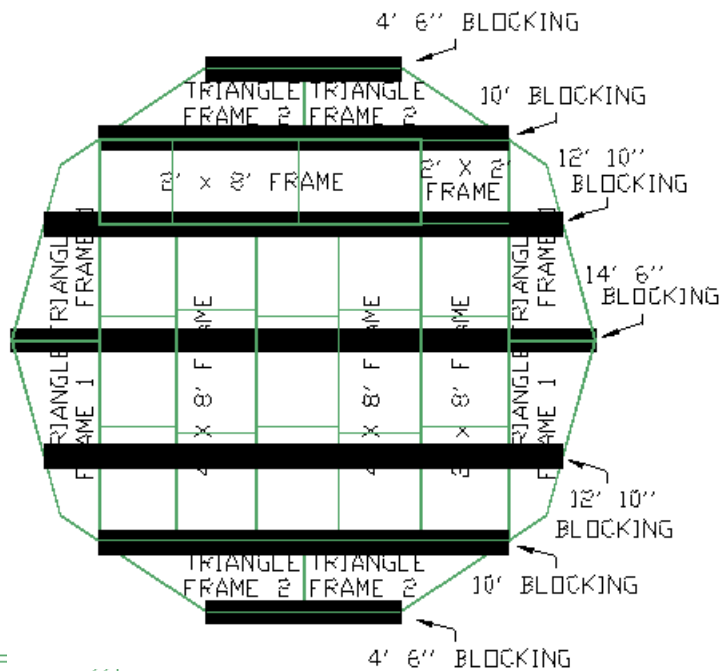

Once the floor sections are blocked and level, nail seams together with one row of 3" nails at 12" on center from both sides as shown to the left with the two 4'x8' frames, one 2'x8' frame, and two "No. 2" triangular frames.

Step 4:

Sheath the floor sections with the 5/8" thick treated plywood provided. Install the sheets in sequence from "A" to "I" as shown to the right. Use the 2" nails for nailing the plywood to the frame. Please note that small gaps around the perimeter of the frame are normal and will not effect the assembly, nor appearance of your gazebo.

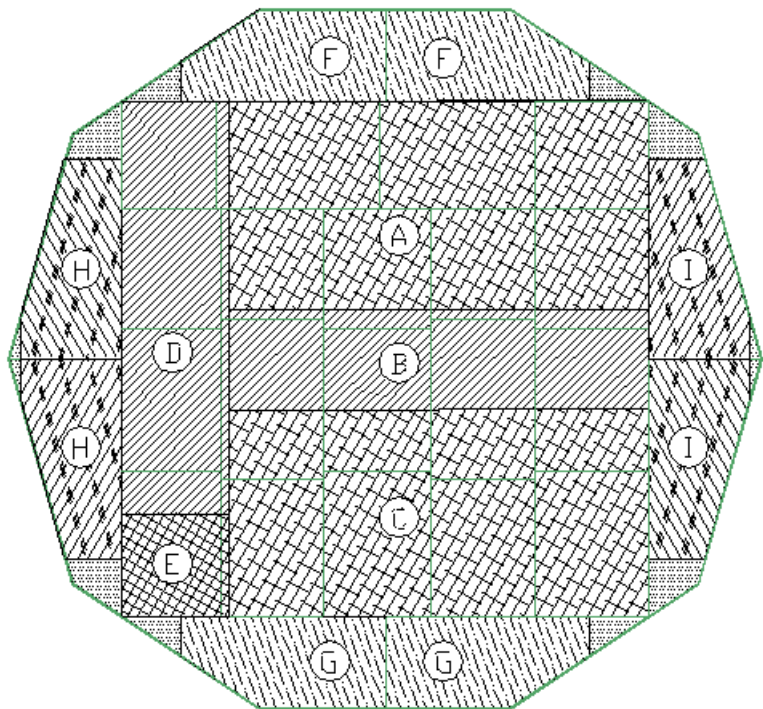

Step 5:

Stand up the door panel in its desired location, keeping the outside of the framing flush with edge of the floor framing. Erect remaining panels, fastening them together with three 3" screws, one at the top, middle and bottom of each panel. After all wall panels have been erected nail each section to the floor with two 3" nails. If the panels do not line up properly, check blocking to ensure the floor system is level and that the walls are plumb.

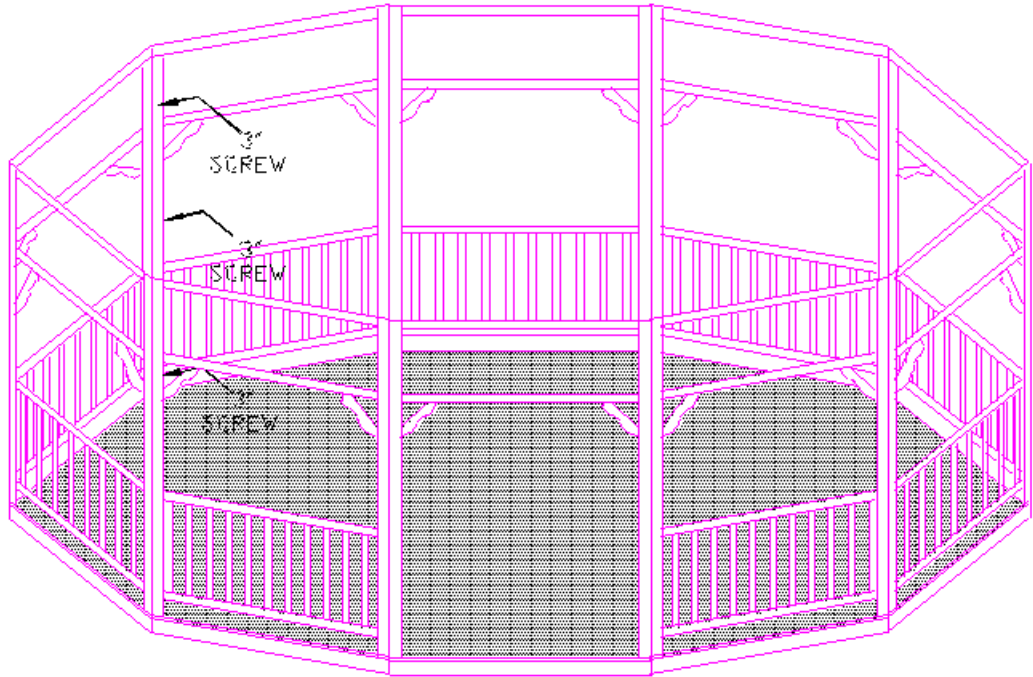

Step 6:

Install the lattice panels in the top portion of each wall panel, flush with the outside of the frame. Hang gate level with adjacent wall railings using the hinges and gate latch provided, install them in the locations illustrated below.

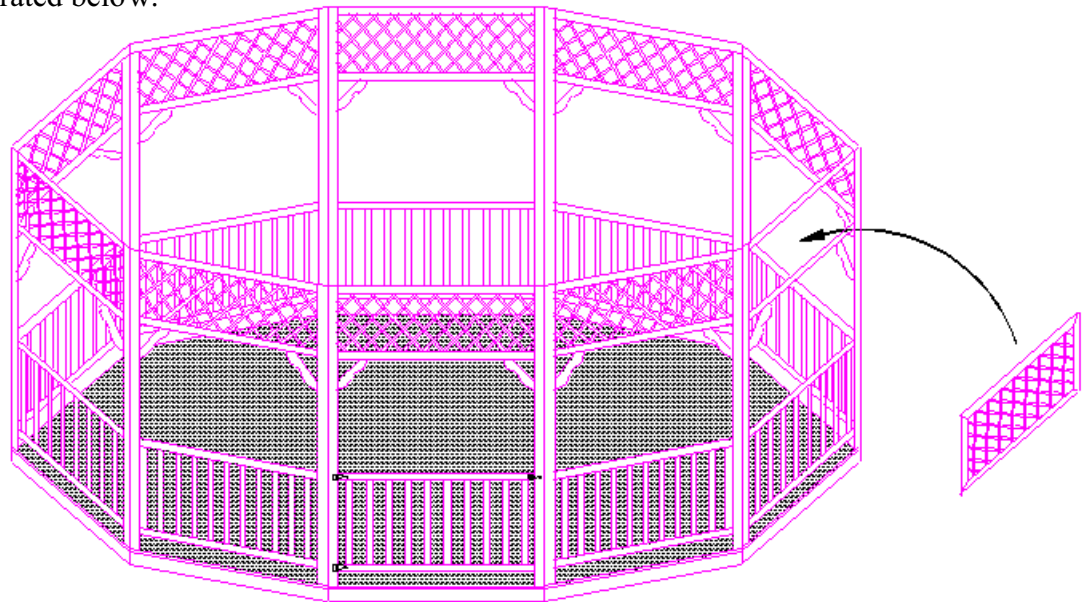

Step 7:

To erect the roof, take the roof peak (a piece of 4" pipe, 3 3/4" long) and screw two rafters to it on opposite sides of the pipe using two screws for each rafter, keeping top of pipe flush with top of rafter. Place the two assembled rafters across the gazebo diagonally at the panel joints. The notch at the tail end of the rafter should fit snug against the outer edge of the wall perimeter. Make sure the center of the rafters line up with the panel joints. If the notch does not fit snug, either push wall out or the roof peak up, to make them fit well.

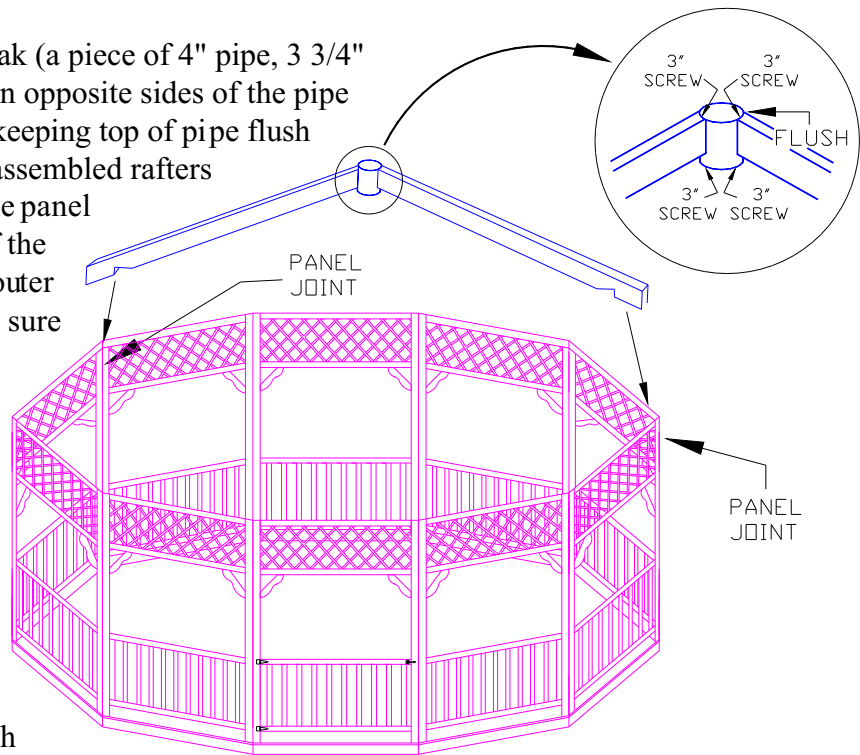

Fasten each rafter to the wall panel with 3" nails. Fasten remaining rafters to roof peak with two screws in each rafter and two nails fastening rafter to wall perimeter.

Step 8:

Install fascia boards. The top of the fascia board should be about 1/4" below the top of the rafter as the roof sheet must sit on top.

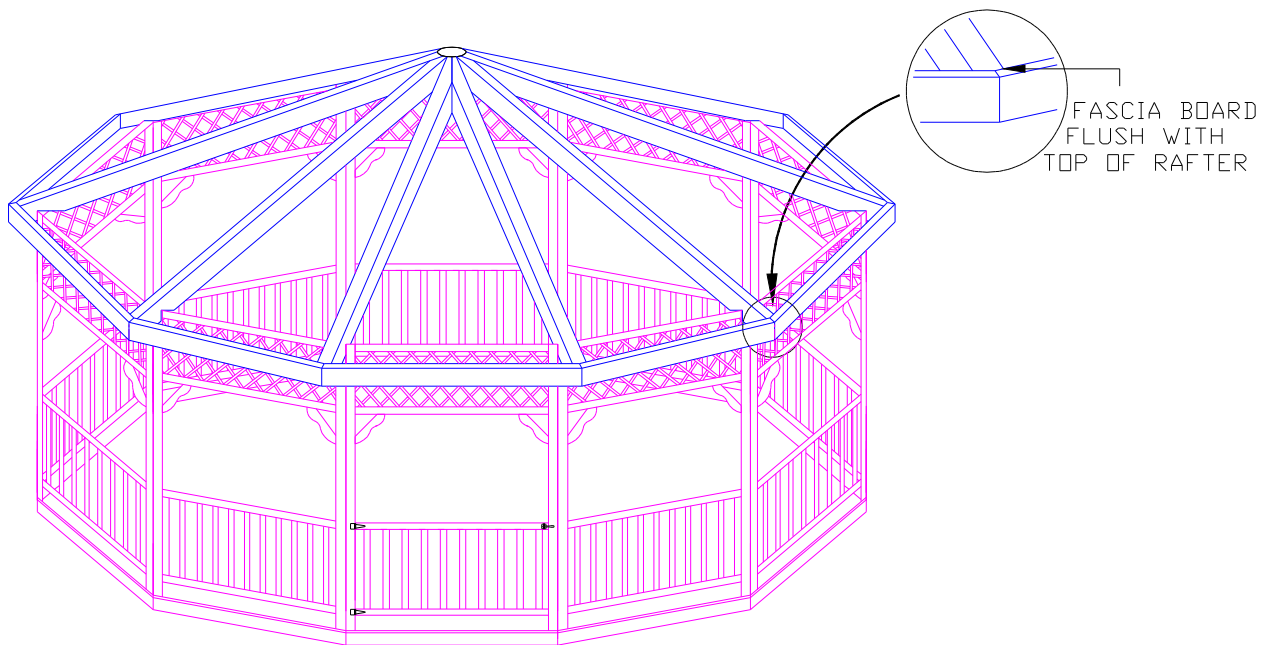

Step 9:

Sheath the roof with 1/2" plywood, keeping the bottom edge of the plywood flush with the fascia. It is important when installing the roof sheathing that each section of plywood meets its adjacent section at the center of each roof rafter. Install all of the largest sheets of plywood first, place the H Clips (not shown) between the upper and lower sheets, and then proceed to install the triangular pieces at the peak of the roof, and finally the small wedges at the base of the roof. If you climb on the roof for any reason, distribute your weight onto the roof rafters. Shingle roof with your choice of shingles.

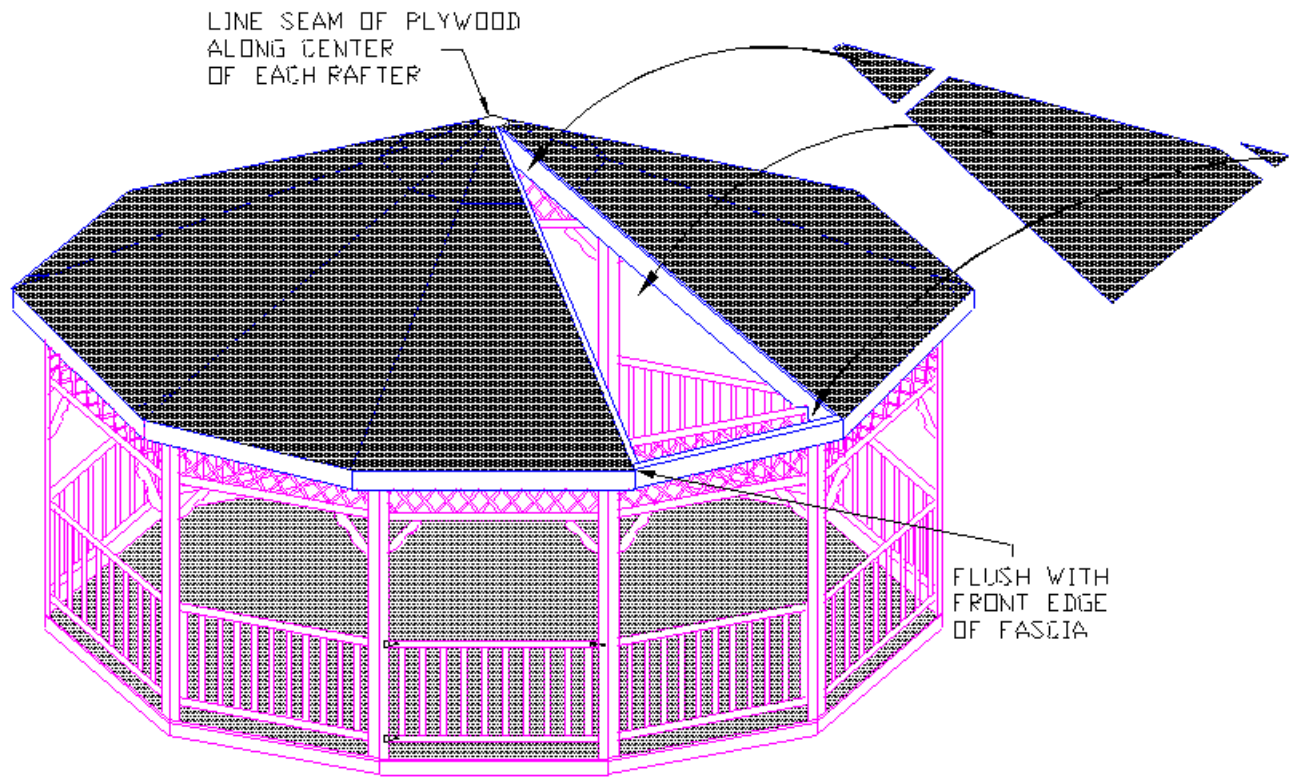

Step 10:

Nail a vertical corner board to each wall panel joint, between the vertical 2"x 4" posts, using finishing nails. Also using finishing nails, attach the cedar floor fascia to the base of each wall panel.

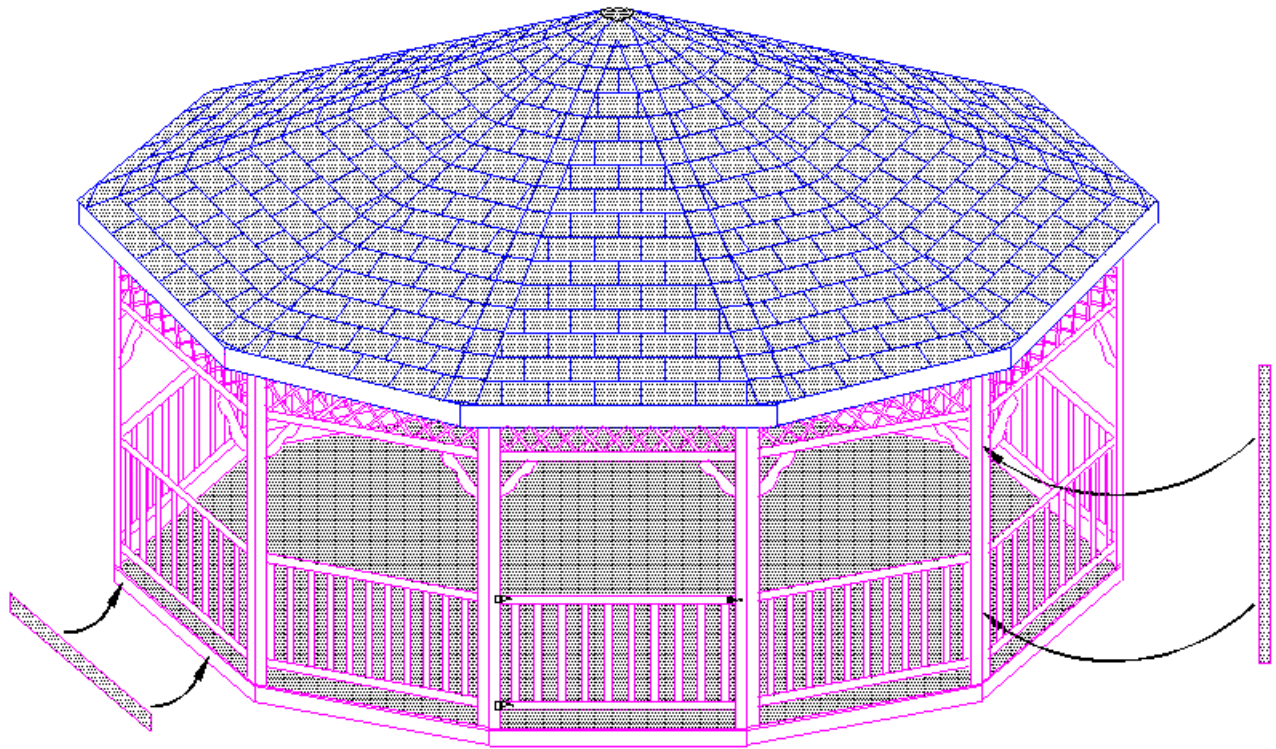





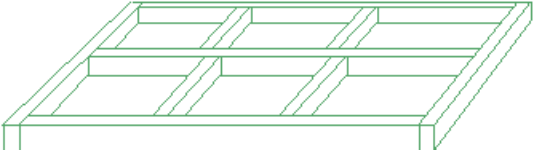
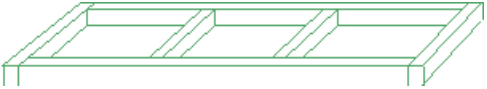

Step 11:

To preserve the beauty of your cedar Gazebo you must stain or varnish it within a few days of installation. You may want to sand any rough edges, and stamps, to produce a better finish.

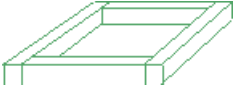
Materials List for the 14' MONARCH Gazebo

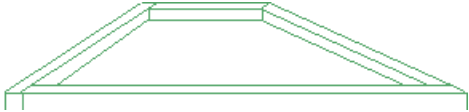
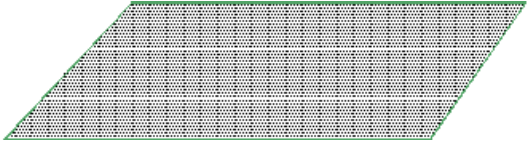
Norfab has taken great care to ensure all parts are of quality material and complete. Please check the unit over carefully. Should you experience any problems DO NOT CALL the STORE! Contact Norfab immediately at 1 800 465 2918 and they will look after you.

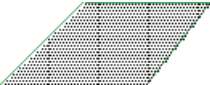
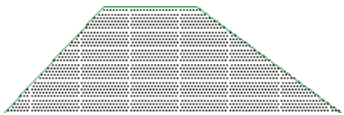
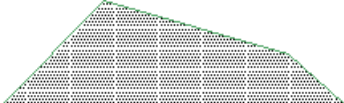
	QTY	DESCRIPTION	
Floor system:	2	4'x8' floor section One with blocking One without blocking	
	2	2'x8' floor section with blocking	
	4	2" x 4" x 21 3/4" blocks	
	1	2 x2' floor section	
	4	No. 1 triangular floor sections	
	4	No. 2 triangular floor sections	
	2	4'x8' sheets 5/8" treated plywood	
	2	2'x8' sheets 5/8" treated plywood	
	1	2'x2' sheet 5/8" treated plywood	
	4	Triangular 5/8" treated plywood	
4	Triangular 5/8" treated plywood		

10

Cedar floor fascia

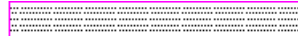

Wall Panels:

9

Wall panels

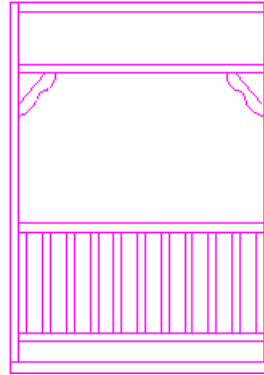

10

Lattice panels

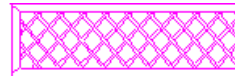

1

Door panel

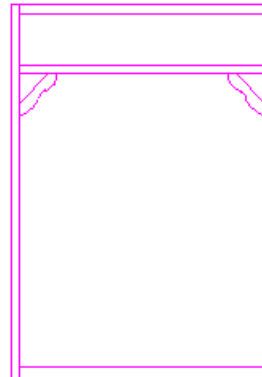

1

Gate

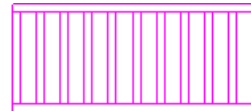

10

Cedar corner



boards

**Roof
Components:**

- 1 Roof peak (3 3/4" piece of 4" pipe) 

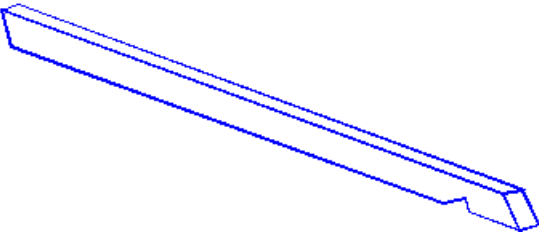
- 10 Rafters 

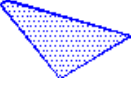
- 10 1/2" plywood triangles 

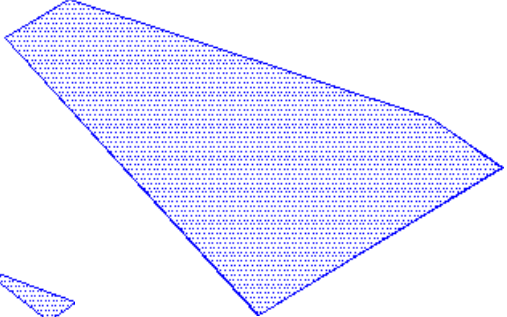
- 10 1/2" plywood sheathing 

- 10 1/2" plywood wedges 

- 10 Cedar fascia boards

- Other:**
- 1 H Clips 
 - 1 Gate latch and hinges
 - 1 Bag 3" nails
 - 1 Bag 2" nails
 - 1 Bag finishing nails
 - 1 Bag 3" screws

Inspected by: _____ Date: _____